

Dämpare och maskinfötter

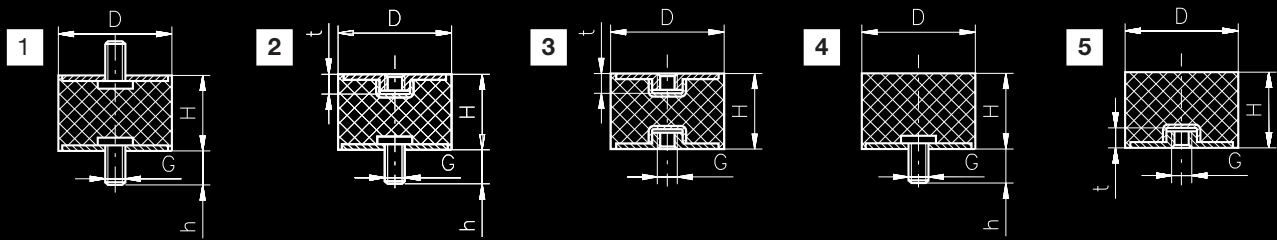

FORMGUMMIGRUPPEN

Cylindrical vibration dampers



D	H	1	2	3	4	5	G	h	t
10	10	●	●	●	●	●	M4	10	3
10	15	●	●	●	●	●	M4	10	3
15	10	●	●	●	●	●	M4	10	3
15	15	●	●	●	●	●	M4	10	3
15	20	●	●	●	●	●	M4	10	3
15	30	●	●	●	●	●	M4	10	3
20	5	○	○	○	●	○	M6	18	6
20	10	●	○	○	●	●	M6	18	6
20	13,5	●	●	○	●	●	M6	18	6
20	15	●	●	○	●	●	M6	18	6
20	20	●	●	●	●	●	M6	18	6
20	25	●	●	●	●	●	M6	18	6
25	10	●	○	○	●	●	M6	18	6
25	15	●	●	○	●	●	M6	18	6
25	17	●	●	○	●	●	M6	18	6
25	20	●	●	●	●	●	M6	18	6
25	25	●	●	●	●	●	M6	18	6
25	30	●	●	●	●	●	M6	18	6
30	15	●	●	○	●	●	M8	20	8
30	20	●	●	●	●	●	M8	20	8
30	25	●	●	●	●	●	M8	20	8
30	30	●	●	●	●	●	M8	20	8
40	20	●	●	○	●	●	M8 (M10)	23 (28)	8 (10)
40	25	●	●	●	●	●	M8 (M10)	23 (28)	8 (10)
40	30	●	●	●	●	●	M8 (M10)	23 (28)	8 (10)
40	40	●	●	●	●	●	M8 (M10)	23 (28)	8 (10)
50	20	●	●	○	●	●	M10	28	10
50	30	●	●	●	●	●	M10	28	10
50	40	●	●	●	●	●	M10	28	10
50	45	●	●	●	●	●	M10	28	10
50	50	●	●	●	●	●	M10	28	10
70	45	●	●	●	●	●	M10	25	10
75	25	●	●	○	●	●	M12	37	12
75	40	●	●	●	●	●	M12	37	12
75	50	●	●	●	●	●	M12	37	12
100	40	●	●	●	●	●	M16	41	16
100	55	●	●	●	●	●	M16	41	16
100	75	●	●	●	●	●	M16	41	16
100	100	●	●	●	●	●	M16	41	16
150	40	●	●	○	●	●	M20	46	20
150	100	●	●	●	●	●	M20	46	20

Rubber quality: NR, NBR, CR, EPDM

Metal finish: St37 galvanized

Hardness: 40, 55, 70 Shore A

Ordering samples: 40/30-1 M8*23 NR55 <- D/H-Type G(*h)

Parabolic dampers

KP-4

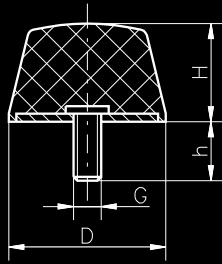

KP-5

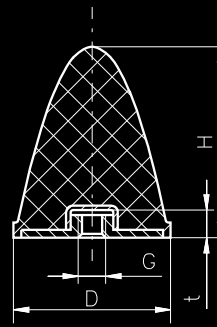

D/H	D	H	G	h	t
20/24	20	24	M6	18	6
30/30	30	30	M8	20	8
30/36	30	36	M8	20	8
50/61	50	61	M10	28	10
75/89	75	89	M12	37	12

Conical dampers

K-4

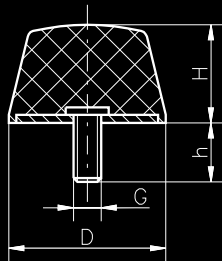

K-5

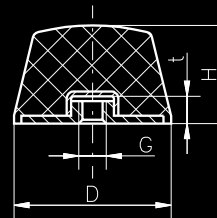

D/H	D	H	G	h	t
25/17	25	17	M6	18	6
50/18	50	18	M10	28	10
125/45	125	45	M16	46	16

DS mounts

DS-4

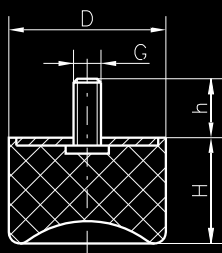

DS-5

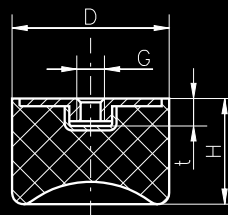

D/H	D	H	G	h	t
25/18	25	18,5	M6	18	6
40/28	40	28,5	M8	23	8
50/28	50	28,5	M10	28	10

Rubber quality : NR, NBR, CR, EPDM
Metal finish: St37 galvanized
Hardness : 40, 55, 70 Shore A

Ordering samples : **K-4 50/18 M10*28 NR55** <- Type D/H G(*h)

The variety of our tools is continuously widening. In case of size not shown by our data sheet, please contact us. We are able to manufacturing articles, which meet your requirements.

Machine feet

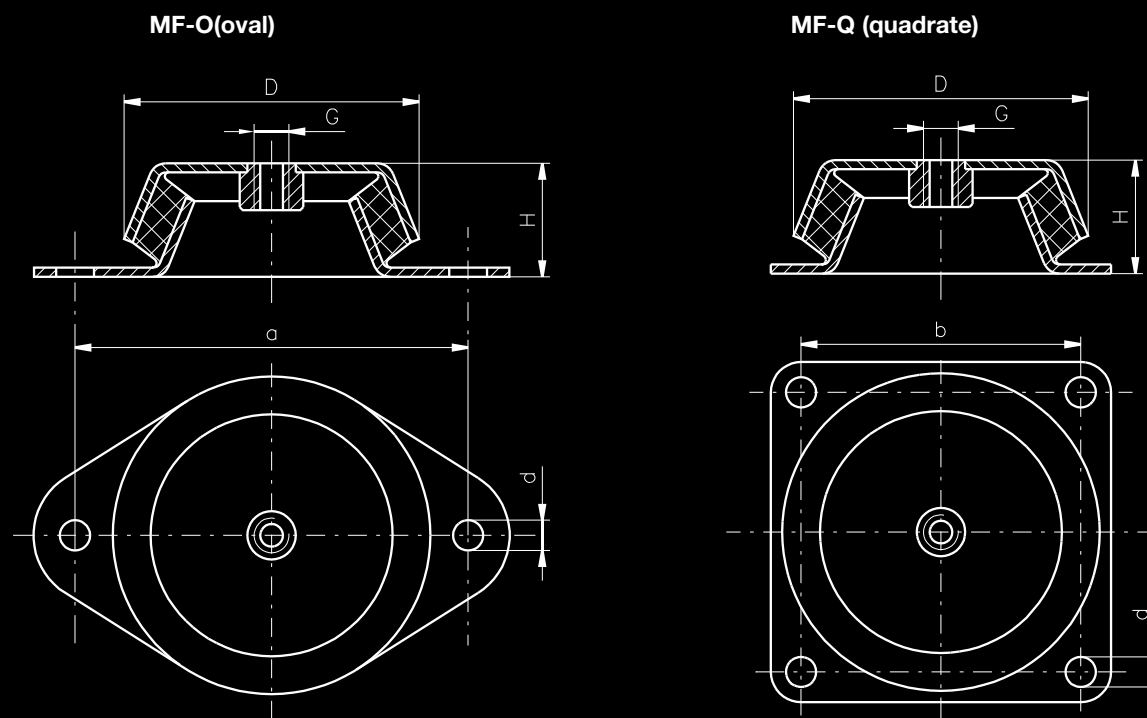

D/H	D	H	d	G	a	b	Load (daN) NK45	Load (daN) NK60
65/28	65	30	8,2	M10	85	55	50	110
94/42	94	45	10,2	M12	110	80	140	300
110/39	110	39	12,4	M12	140	100	180	450
162/58	162	60	16,2	M16	200	145	550	900

Rubber quality :

NR, NBR, CR, EPDM

Metal finish:

Top : St37 galvanized yellow chromated

Bottom: Black, painted

Hardness:

45, 60 Shore A

Ordering samples :

MF-O 110/39 NR60 <- Type D/H

Hör gärna av Er till oss!

Vi klarar det mesta inom gummi och plast.

Säljavdelningar Formgummigruppen AB

NORD

Brudtallsvägen 14

SE - 792 32 Mora

Sweden

Tel +46 250 158 80

Fax +46 250 152 68

SYD

Brogatan 23

SE - 302 43 Halmstad

Sweden

Tel +46 350 158 280

Fax +46 350 103 032



info@formgummigruppen.se

www.formgummigruppen.se